

IDAHO 3 PERS. MED CHAISELONG

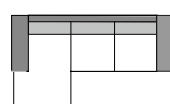

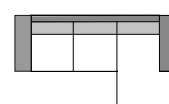





VENDBAR



D3





3D

A		11
B		11
C		11
D		1
E		8
F	 Plastic washer for legs	8
G		1
H		1



EXTRA		Metal washer for leg	1
-------	---	----------------------	---

Please note.
This extra metal washer is needed in that case if your floor is a little bit uneven, and one of the legs is hanging in the air. Use this washer in between one of the legs and the sofa frame. For the sofa to be stable.

2		
B		3
C		3

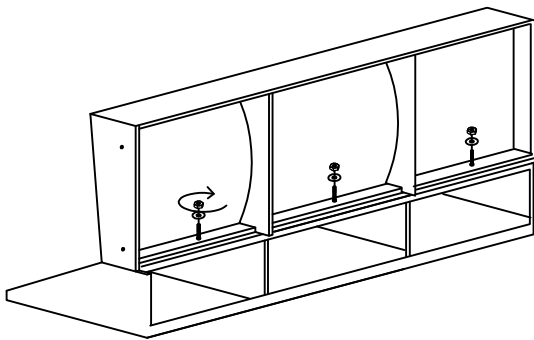
Place the seat in top of the back above the bolts, add washers and assemble nuts on each bolt, **but keep it loose.**



4		
B		8
C		8

Put the armrest together with the backrest and the seat. Assemble washers and nuts, **but keep it loose.**

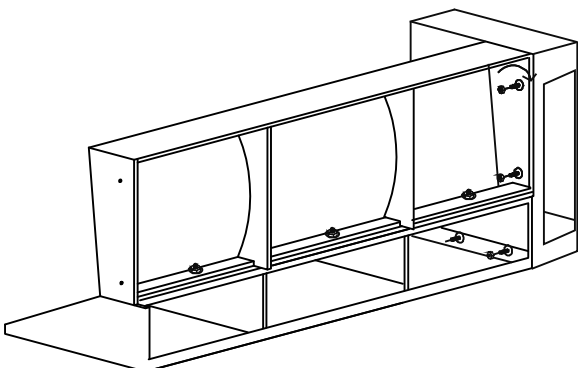

1		
A		3

Place the back on a smooth surface and assemble a bolt in each hole.

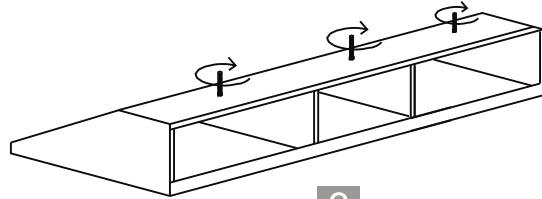

3		
A		8

Assemble one bolt in each hole in the armrest.

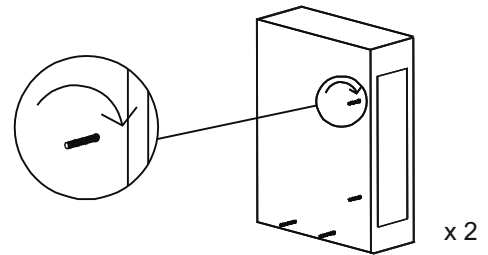

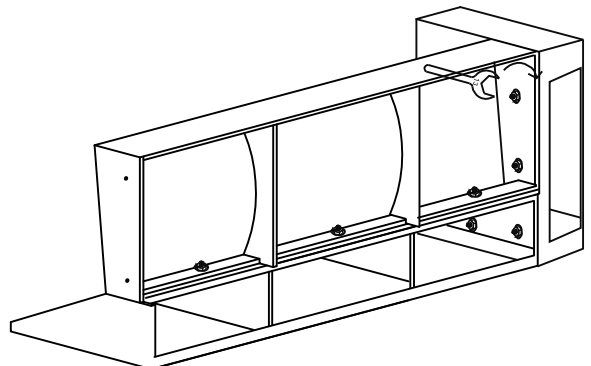

5		
D		1

Check that all joints are smooth. Then screw all nuts tightly.



6



E		8
F	 Plastic washer for legs	8

Note where the legs shall be placed.

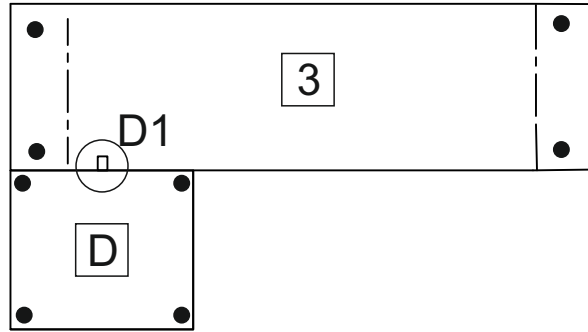
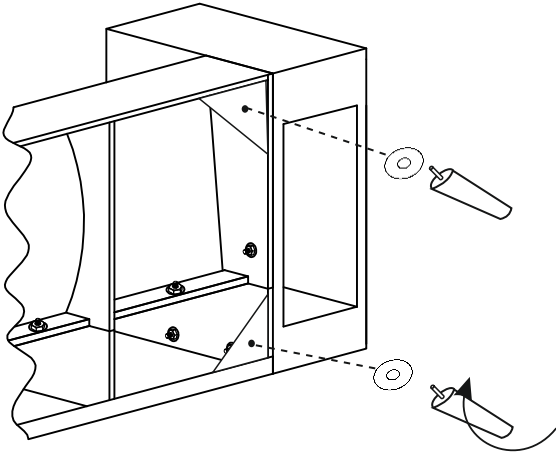
Assemble the legs.



7

G		1
H		1

Assemble the hook on the divan foot-stool.
Now assemble all sections together with the hook.

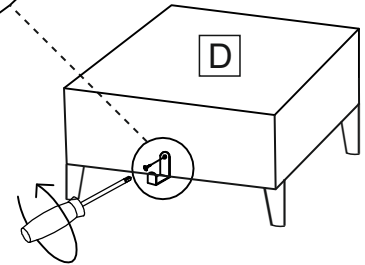
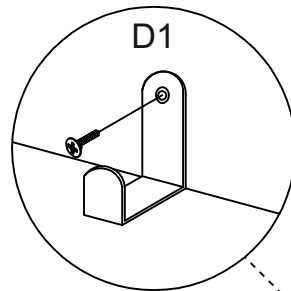

EN

- Do not throw away the packing materials until assembly is complete;
- To avoid scratch or other damages: assemble this item on a soft surface, such as cardboard or carpet, to protect finish;
- Hardware may loosen overtime. Periodically check that all connections are tight ;
- Protect sofa from an environmental factors such as : heat, direct sunlight(especially leather surface) and humidity;
- Do not use sofa outdoors.



- Dry cleaning
40° degree machine wash
Ironing, low temperature (one dot)